



Operation Manual GPS Receiver set
for PQI-DA *Smart* Art.No. 111.7083 / RS485



Note:

Please be aware that this user guide cannot relate to the current version of the device in any case. For example, if the firmware has been upgraded via internet, this user guide may not be compatible at any point.

In this case, either contact us directly or refer to the most recent version of the operation manual, available on our website (www.a-eberle.de).

A. Eberle GmbH & Co. KG

Frankenstraße 160

D-90461 Nuremberg

Phone: 0911 / 62 81 08 0

Telefax: 0911 / 62 81 08 99

E-Mail: info@a-eberle.de

Internet: www.a-eberle.de

A. Eberle GmbH & Co. KG cannot be held liable for any damage or losses resulting from printing errors or changes to this user guide.

Furthermore, **A. Eberle GmbH & Co. KG** does not assume responsibility for any damage or losses resulting from defective devices or from devices altered by the user.

Copyright 2017 by A. Eberle GmbH & Co. KG

Subject to change.

Contents

| | | |
|-----------|--|----------|
| 1. | User Guidance..... | 4 |
| 2. | Scope of Delivery | 5 |
| 3. | Safety Instructions | 6 |
| 4. | Technical Data | 7 |
| 4.1 | GPS – Antenna - 111.7081.01 | 7 |
| 4.2 | GPS – Converter 111.9024.62 with RS485 output | 8 |
| 5. | GPS - Antenna | 8 |
| 6. | Commissioning for PQI-DA <i>smart</i>..... | 9 |
| 6.1 | Connection of GPS Converter 111.9024.62 to PQI-DA <i>smart</i> | 9 |
| 6.2 | Cable Termination at PQI-DA <i>smart</i> | 10 |
| 6.3 | Parameter Setting PQI-DA <i>smart</i> GPS/NMEA | 11 |
| 6.4 | Checking Signal Quality and Synchronization | 12 |
| 6.4.1 | PPS - Signal | 12 |
| 6.4.2 | NMEA - Protocol..... | 13 |

We take care of it.

1. User Guidance



Warnings

Gradation of warnings

Warnings are distinguished by the type of danger they are warning against:

- **Danger** warns of mortal danger
- **Warning** warns of injuries
- **Caution** warns of material or environmental damage

Structure of the warnings

| | |
|--|---|
|  | Nature and source of danger |
| Signal word |  Actions to avoid the danger. |

Notes



Notes of the appropriate use and recommendations.

Other symbols

Instructions

Structure of the instructions:

-  Instructions for an action.
- Indication of an outcome, if necessary.

Lists

Structure of unnumbered lists:

- List level 1
 - List level 2

Structure of numbered lists:

- 1) List level 1
- 2) List level 1
 1. List level 2
 2. List level 2

We take care of it.

2. Scope of Delivery

The GPS Receiver Set for PQI-DA *Smart* Art. No. **111.7083** consists of:













- **111.7081.01** GPS – Antenna - Navilock NL-8004P incl. special parameter setting for PQI-DA *Smart*
- **111.9024.62** GPS Converter Navilock-PQI-DA *Smart* with RS485 output
- **583.0336** Angle support

▶ **Options to set 111.7083**

- **111.7079** Power supply 24V for top-hat rail (for supply of GPS Converter 111.9024.62)

We take care of it.

3. Safety Instructions

-  Follow the operating instructions.
-  Keep the operating instructions near the appliance.
-  Do not use the device, if it is not in impeccable condition.
-  Do not open the device casing.
-  Only qualified persons are permitted to operate this device.
-  Connect the device as specified.
-  The device may only be operated in original condition.
-  Only use recommended accessories.
-  Make sure the device is not operated above the design limits.
(Refer to technical data)
-  Make sure the recommended accessories are not operated above design limits.
-  Do not use the device in environments, where explosive gases, dust or fumes occur.
-  Only clean the device with commercially available cleaning agents.

We take care of it.

4. Technical Data

4.1 GPS – Antenna - 111.7081.01

The GPS Antenna 111.7081.01 with u-blox 8 chipset is equipped with a built-in antenna. Highly accurate time synchronization is available in conjunction with GPS Converter 111.9024.62 with RS485 – output and a PQI-DA *smart*.

| Power supply | |
|--------------|-----------|
| Voltage | 5 V DC |
| Current | max 45 mA |

| Dimensions | |
|---------------------|--------------------|
| Cable length | 5 m |
| Protocol (electric) | RS232 with 4800 Bd |
| Protocol | NMEA |

| Physical dimensions / Weight | |
|------------------------------|---------------|
| ∅ x H (without thread): | 62 mm x 21 mm |
| Weight | 200 g |

We take care of it.

4.2 GPS – Converter 111.9024.62 with RS485 output

The GPS – Converter - 111.9024.62 is used to pass the PPS signal to the clamps (5-6) and convert the RS232 NMEA time signal of the GPS receiver to the RS485 clamp (3-4). These two signals allow the synchronization of 32 PQI-DA *smart* with a total bus-length of 1200 m at both COM interfaces.

| Dimensions | |
|-----------------------------|--------------------|
| Cable length | 5 m |
| Protocol | RS232 with 4800 Bd |
| Physical dimensions/ Weight | |
| L x W x H | 160 x 90 x 58 mm |
| Weight | 500 g |

| Electrical Safety | |
|------------------------------------|----------|
| — IEC 61010-1 — IEC 61010-2-030 | |
| Protection class | 2 |
| Degree of contamination | 2 |
| Height | ≤ 2000 m |
| IP Protection class | IP20 |

5. GPS - Antenna

The GPS Antenna 111.7081.01 needs to be installed to a place, where free sight to GPS satellites is available. For this purpose, the angle support with screw set No. 583.0336 is included in the standard scope of delivery. The antenna is connected to the GPS converter by the provided connection cable (length 5 m). It transmits the time signal to the converter via NMEA protocol. The antennas power supply is provided by the GPS converter.



We take care of it.

6. Commissioning for PQI-DA *smart*

6.1 Connection of GPS Converter 111.9024.62 to PQI-DA *smart*

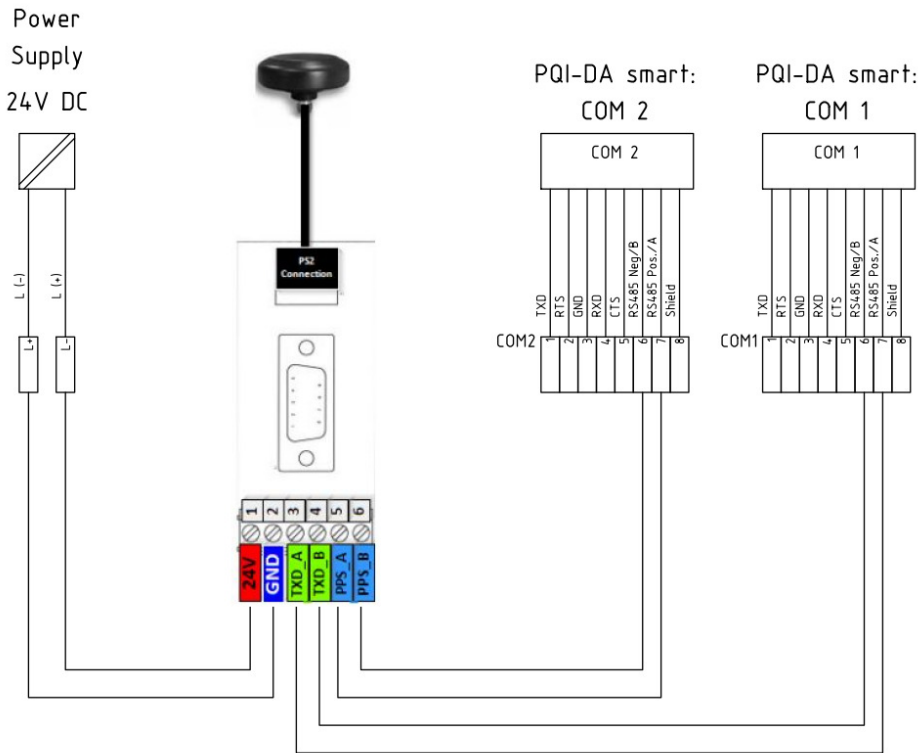

- Establish the electrical connection between GPS converter and PQI-DA *Smart*:

| GPS Converter 111.9024.62 | PQI-DA <i>Smart</i> |
|---------------------------|---------------------|
| Pin 3 – TXD_A | COM1 – Connection 7 |
| Pin 4 – TXD_B | COM1 – Connection 6 |
| Pin 5 – PPS_A | COM2 – Connection 7 |
| Pin 6 – PPS_B | COM2 – Connection 6 |

The electrical connection between GPS converter and PQI-DA *smart* is established by RS485 bus. According to the specification of RS485, a total bus-length of 1200 m and a maximum number of 32 PQI-DA *smart* devices is possible.

- Plug the GPS antenna to the PS2 socket of the converter (after the antenna has been attached to the roof or to the provided support angle).
- Supply the converter by Pin1(+24V) and Pin2(-). The top-hat rail power supply (Art. No. 111.7079) may be used, if no 24 V power supply is available.

We take care of it.

6.2 Cable Termination at PQI-DA smart

For one PQI-DA Smart participant:

- Bus termination COM1 & COM2.

For various PQI-DA smart participants:

- Bus termination at first and last PQI-DA smart participant.

► Example for termination:

Connection of three PQI-DA Smart devices to one GPS module → the bus of the first and the last device needs to be terminated!

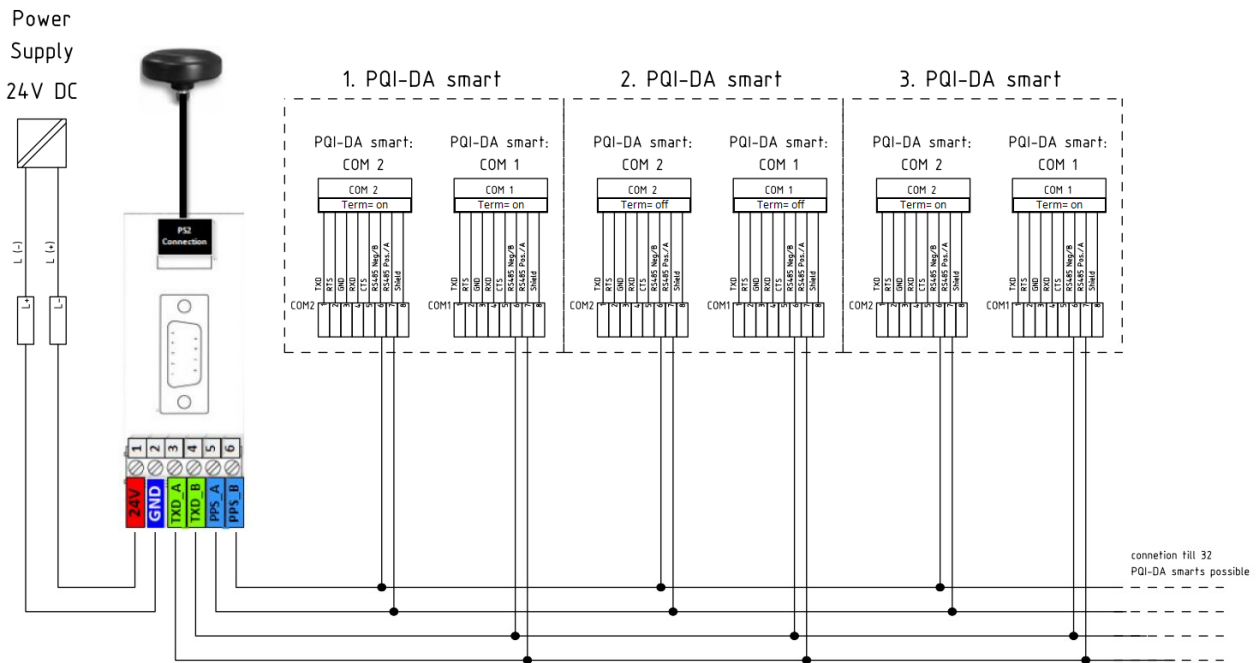

► Termination via switch

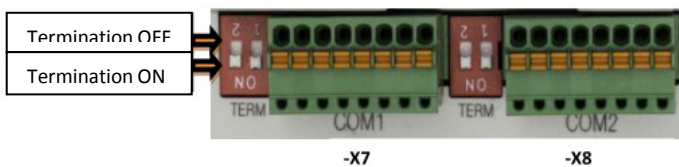

We take care of it.

6.3 Parameter Setting PQI-DA *smart* GPS/NMEA

The following settings must be made:

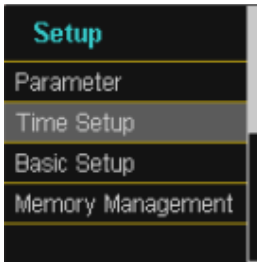

Enter "Time Setup" via return button.

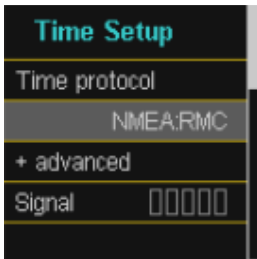

Select Time protocol "NMEA: RMC".

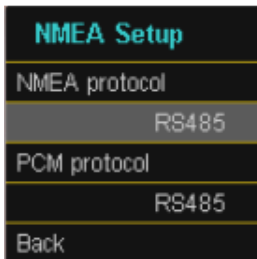

Set the NMEA and PCM protocol to "RS485" in "advanced" menu and return to "Time Setup".

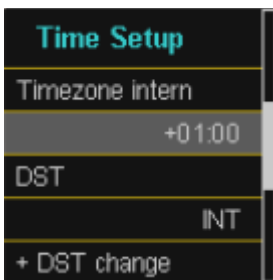

Enter the time zone on the second page. The default setting is "1" for Germany with automatic Summer-/ Wintertime switching.

After all settings are made, the PQI-DA *Smart* is able to receive the current time by the GPS receiver. The time is evaluated with the PPS signal and the device synchronizes to reference time.

We take care of it.



Both COM interfaces are needed for connecting the GPS receiver (Time Protocol + PPS signal). Therefore other applications e.g. Modbus RTU are blocked.

6.4 Checking Signal Quality and Synchronization

6.4.1 PPS - Signal

The PQI-DA *smart* provides the possibility to check the signal quality of the PPS (pulse per second) signal. This option may be accessed by the following steps:



Enter „Time Setup“ via return button.

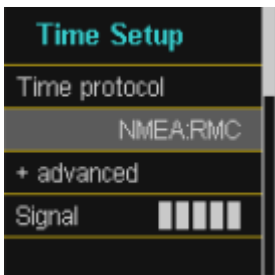

The signal quality is illustrated as a bar diagram in “Time Setup”. At least one filled bar needs to be visible. In other cases, the synchronization precision lies at +/- 1 s.

The PPS signal with the following impulse curve measured between pin5 and pin 6 synchronizes the time received by RS485 once a second. This allows a highly precise synchronization with low latency and super low jitter.

We take care of it.

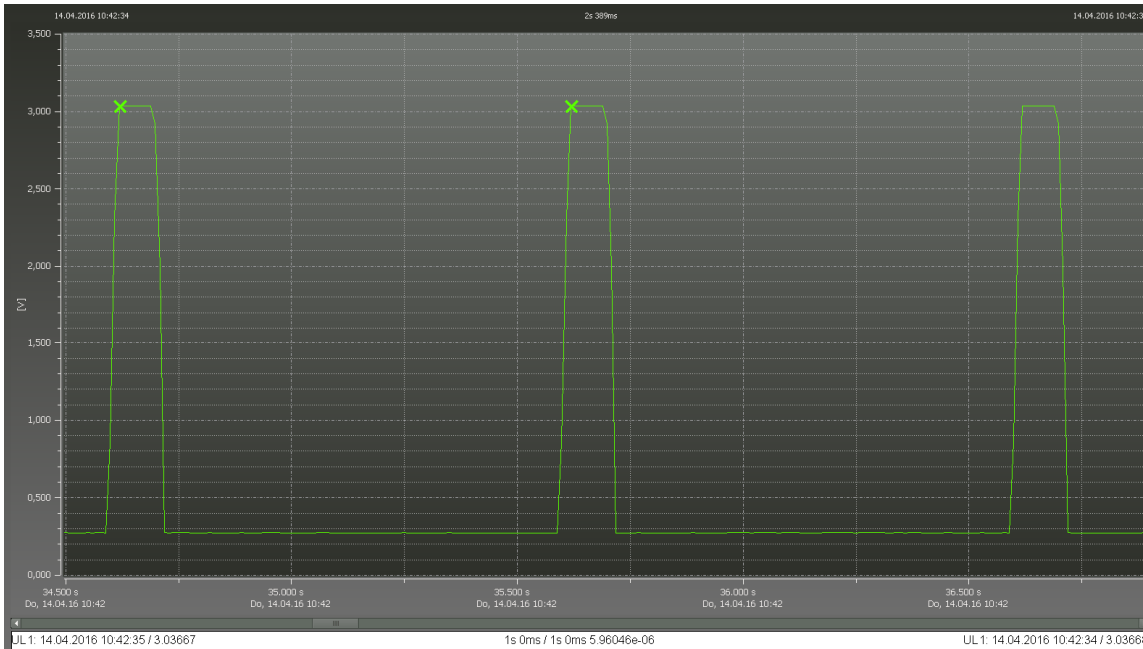

6.4.2 NMEA - Protocol

To check whether the antenna adjustment was successful, the following options are available:

1. Connect the serial interface of the GPS converter to a PC with a terminal program (e.g. Putty – <https://www.heise.de/download/product/putty-7016>) with the following connection parameters:
4800Baud / 8N1 / RTS-CTS.
For this purpose a null modem cable needs to be used.
2. In case of a successful connection, the following string is sent by the GPS antenna once a second:

```
„$GNRMC,081742.00,A,4925.70887,N,01105.40026,E,0.241,,310317,,,A*69“
```

If the letter “A” appears at the third position, GPS reception is available and the time signal is valid.

▶ **Detailed description of all parameters:**

```
$GPRMC,162614,A,5230.5900,N,01322.3900,E,10.0,90.0,131006,1.2,E,A*13  
$GPRMC,HHMMSS,A,BBBB.BBBB,b,LLLLL.LLLL,l,GG.G,RR.R,DDMMYY,M.M,m,F*PP
```

We take care of it.

| Symbol | Meaning |
|--|--|
| HHMMSS or HHMMSS.SSS | Time (UTC) |
| A | Status (A for <i>OK</i> , V for warnings) |
| BBBB.BBBB | Latitude |
| b | Orientation (N for <i>North</i> ; S for <i>South</i>) |
| LLLL.LLLL | Longitude |
| l | Orientation (E for <i>East</i> ; W for <i>West</i>) |
| GG.G | Groundspeed in knots |
| RR.R | Course over the ground (in degree in regard to geographical north) |
| DDMMYY | Date (day month year) |
| M.M | Magnetic deviation |
| m | Leading sign of deviation (<i>E</i> or <i>W</i>) |
| F | Signal integrity : A = Autonomous mode, D = Differential Mode, E = Estimated (dead-reckoning) mode M = Manual Input Mode S = Simulated Mode N = Data Not Valid |
| PP | Hexadecimal representation of the checksum. (the checksum is built by a XOR-combination of all data bytes between "\$" and "*") |

We take care of it.

We take care of it.

A. Eberle GmbH & Co. KG

Frankenstraße 160
D-90461 Nuremberg

Tel.: +49 (0) 911 / 62 81 08-0
Fax: +49 (0) 911 / 62 81 08 99
E-Mail: info@a-eberle.de

<http://www.a-eberle.de>

Version: 11/6/2017 1:58